



# **Microlift**<sup>®</sup>

**THE SERVICE LIFT**

*The most versatile range of service lifts,  
always with structure supporting frame.*



**DALDOSS**  
PASSENGER & GOODS LIFTS



## “Discover the Daldoss world”



Let us think for a moment of the space around us, in all of its three dimensions. Now let us imagine a man moving freely within this space. In two dimensions he will be completely self-sufficient in his movements as his legs will take him wherever he likes. But if he wants to tackle the third dimension, he'll need to hang onto a rope, dangle from a balloon or... use a lift.

DALDOSS conquers the third dimensions.

**Microlift is the ideal solution for private, industrial and commercial applications**

## **Microlift**<sup>®</sup> THE SERVICE LIFT

The **Microlift** range includes models from 24 to 300 kg offering a wide choice of car sizes "of the shelf". Other non-standard sizes are also available.

All the models operate inside a rapidly erected structure supported frame which is galvanised for longer life. "Rise and fall" shutters or single hinged manual landing doors are finished in grey baked enamel RAL 7038 (standard), Daldoss RAL colours range or made in stainless steel AISI

304. The landing push button station is fitted with "lift arrival", "lift occupied" and "lift position" indicators.

**Microlift** can travel up to a maximum 30 meters and up to three entrances can be fitted on each floor. Thanks to the reliable electronic control, efficient motor with high quality reduction gearbox and electromagnetic disk brake, the operation is extremely quiet and safe in any type of installation.

**Microlift is the world largest selling range of service lifts with over 100,000 installations worldwide.** The experience and know-how acquired from over 60 years in the lift industry operating in the most important market worldwide, has led to Daldoss developing a highly modern range of elevators which features cutting edge space-saving technology with a pleasing aesthetical design.

**Microlift** is the ideal solution in restaurants, hotels, chemist's, hospitals, offices, shops and multi level houses for the easy and uncomplicated moving of packages, letters, medicines, crockery and cutlery.



## PHARMACIES

The 24 kg range is the ideal solution for transporting small items with maximum comfort and silence.



## HOSPITALS

For moving any materials, even the most delicate, with maximum safety.



## WAREHOUSES

With the 200-300 kg range is possible to move bulky materials between floors, also with trolleys.



## HOTELS

The essential tool for easier cleaning, also with the double decker model for the double load of goods.



## OFFICES

The mail and storage operations have a great ally in the range 24-50 kg.



## RESTAURANTS

**Microlift** is THE service lift, also thanks to the heating system of the car for the transport of food and the double decker model, fully respecting the sanitary and hygienic regulations.



## Index

5

The other Daldoss products ..... 24

4

Technical Characteristics ..... 18

3

Customization of the service lift..... 16

2

Finishes in detail ..... 14

1

Floor type applications ..... 10

0

Table type applications..... 8



*Installation in a restaurant (UK),  
model 50 kg, with glass cladding.*

*Installation in a bar (Spain),  
model 50 kg with stainless steel cladding*



*Installation in a clothing shop (Italy),  
model 50 kg, glass cladding and standard car  
in RAL 7038.*



# Typical applications



## Table type models

All **Microlift** models operate inside a rapidly erected structure supported frame, which makes installation simple with minimal builder's work. **Microlift** are usually available with short lead time and, subject to builder's work, can be installed and working within a few days.

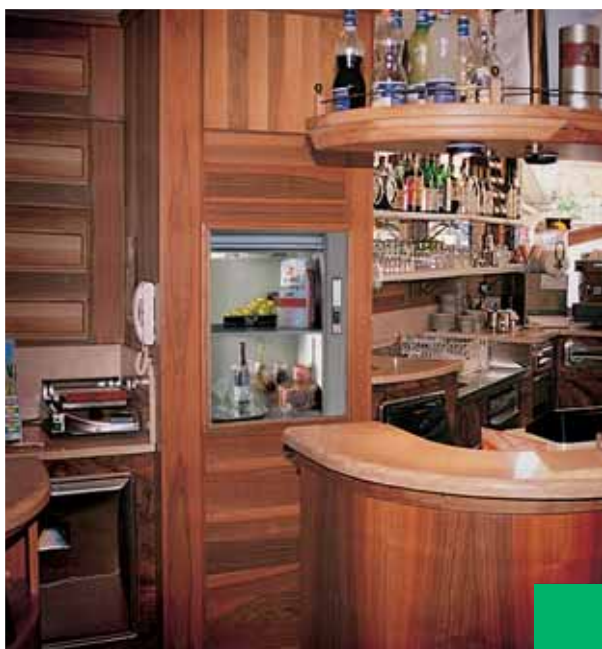

*Installation in a restaurant-bar (Italy), model 50 kg with wood cladding. It perfectly fits the environment.*



*Installation in a clothing shop (Italy), model 50 kg, glass cladding and standard car in RAL 7038*



*Installation in a private house (Italy), model 24 kg with stainless steel finishes. Thanks to **Microlift** the transport of goods from the garage to the kitchen is not a problem.*



*Installation in a copy centre (UK), model 100 kg, car and doors in stainless steel AISI 304.*



## Norms and regulations

- Machinery Directive 2006/42/CE
- Electromagnetic Compatibility 2004/108/CE
- Directive EN 81.3:2000 (accessible and not accessible shaft)

## INSTALLATION

### Table type 3D rendering

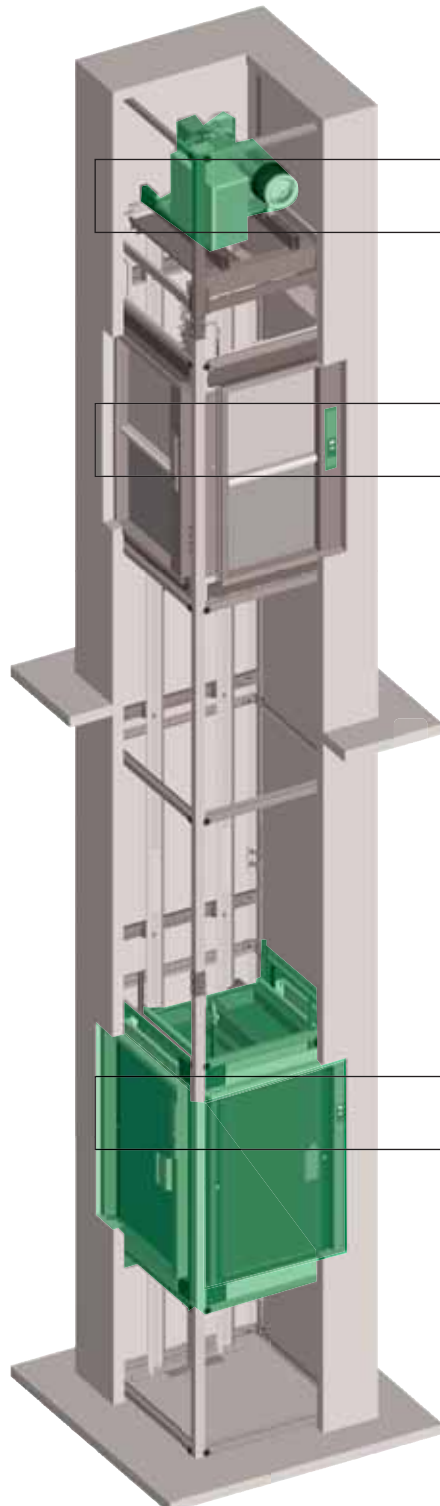

**1**

Drive unit and controller are enclosed in the headroom within the structure supported frame.

**2**

New push button with led. Modern and pleasing design, soft and precise activation and complete impermeability of the electronic elements.

**3**

Car with baked enamel RAL 7038 finish or in stainless steel AISI 304. Manual landing doors with rise and fall shutters or manual single hinged door. Complete RAL colours range available on request.



# Typical applications



## Floor type models

The modularity of components parts facilitates the installations of **Microlift** in any type of building. An opening through each floor, an electrical power supply and shaft enclosure in harmony with the interior design is all that is required to have **Microlift** quickly installed both in existing and new buildings.



*Installation in a bar (Italy), model 100 kg, stainless steel finishes, specific for the food sector.*



*Installation in a warehouse (UK), model 200 kg. Also the biggest equipments can be moved without problem.*



*Installation in a commercial airport (UK), model 300 kg.*



*Installation in a warehouse (Australia), model 300 kg, standard finishes.*



## Spaces and costs saving

**Microlift** has been designed to reduced to the minimum the space occupied by the shaft, saving valuable floor space in the building. No separate motor room or load-bearing lift shaft is required. The low motor power of **Microlift** allows reduced energy consumption and the strength of components guarantee a safer, reliable and solid product. Thanks to the quality of the products, due to first class materials, brake downs are reduced to the minimum.

## INSTALLATION

### Floor type 3D rendering

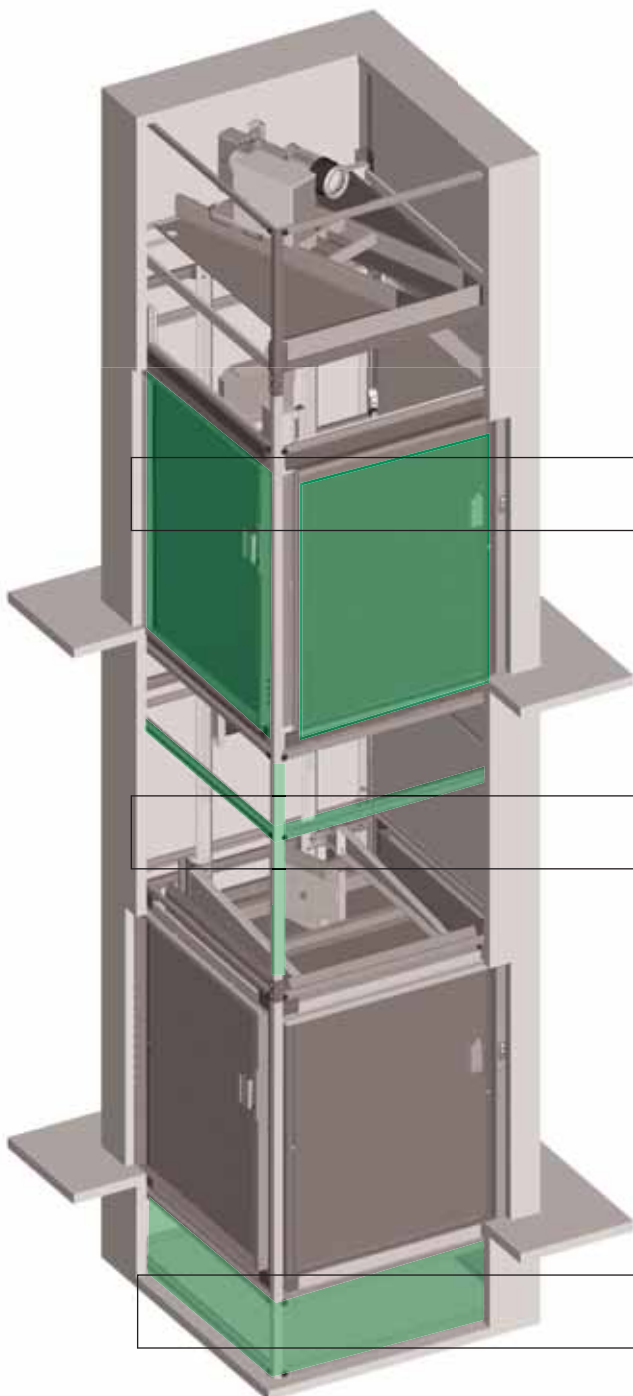

1

For floor type models the doors must be manual single hinged (EN 81.3). Entrances can be adjacent, but with the door opening always on the same side (only right or only left).

2

The modularity of structure supported frame facilitates the installations of **Microlift** in any type of building.

3

The floor type models need always a minimum 400 mm pit (150 mm optional).



*Installation in a shoes shop (Russia),  
model 24 kg, finishes in stainless steel AISI 304*



*Installation in a fast food restaurant (The Netherlands), stainless steel finishes, specific for food sector. Installed with heating kit.*

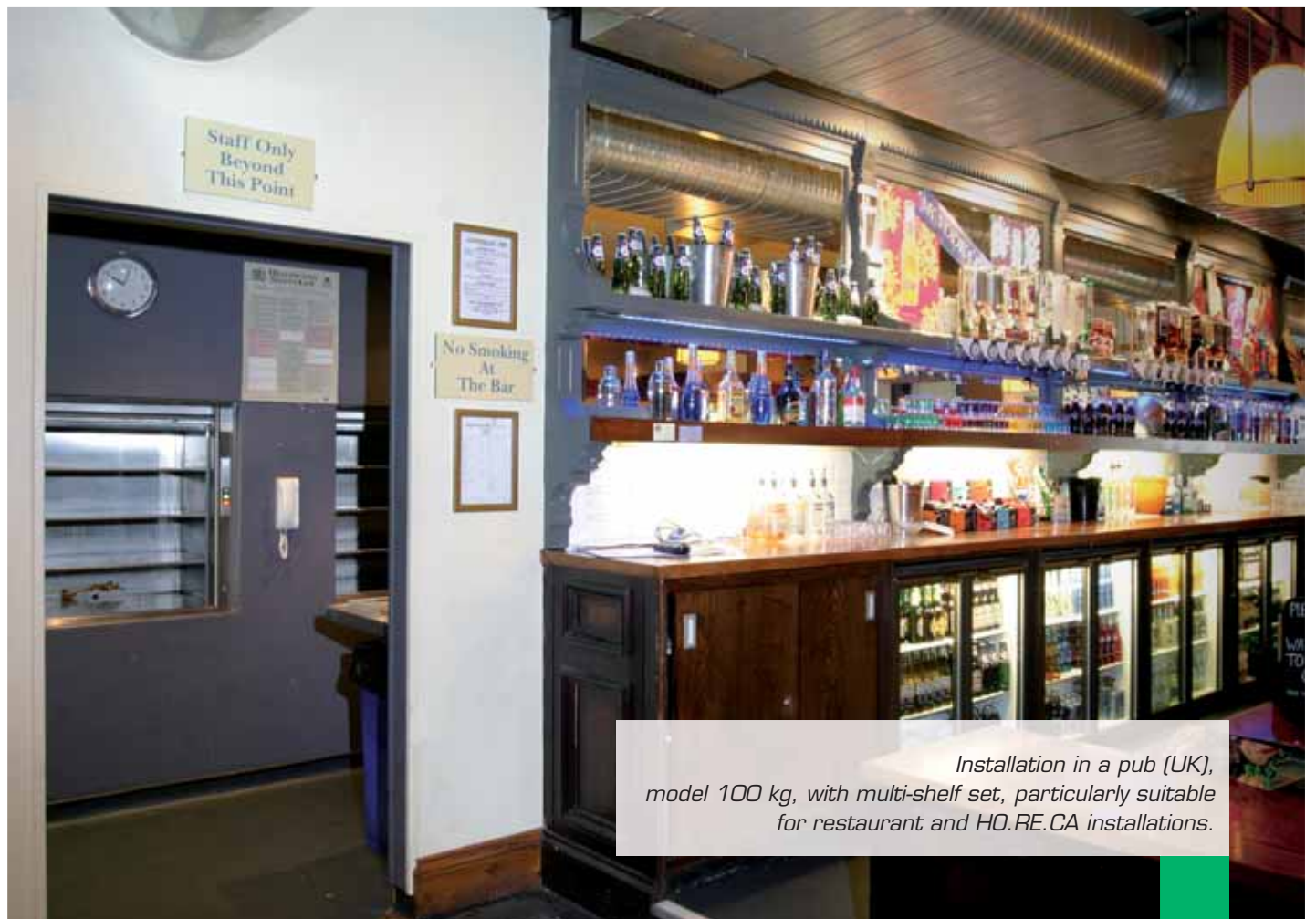

*Installation in a pub (UK), model 100 kg, with multi-shelf set, particularly suitable for restaurant and HO.RE.CA installations.*

# Finishes in details







## Standard and optional components

**Microlift** has been designed and built with extreme attention to quality and strength of materials, for ensuring maximum durability and minimizing maintenance and running costs.

### Standard finishes

Car with baked enamel RAL 7038 finish or in satin stainless steel AISI 304	Manual single hinged door with baked enamel RAL 7038 finish [*]	Manual landing door with rise and fall shutters with baked enamel RAL 7038 finish [*]	Machine room door with baked enamel RAL 7038 finish [*]
			
<p>[*] Daldoss RAL colours range or door in satin stainless steel AISI 304 available on request.</p>			

### Landing indicators in satin stainless steel

<p>Standard call and dispatch push button with led light "lift arrival", "lift position" and "lift occupied" indicators. Audible lift arrival buzzer (available for 2-5 stops)</p> 	<p>Push button panel with emergency STOP push button (optional)</p> 	<p>Push button panel with key switch to activate push button (optional)</p> 	<p>Waterproof push button panel (optional)</p> 
--	---	--	--







## Customized features

**Microlift** range has a wide range of finishes and optional and can be customized by installing accessories to further increase safety and functioning of the lift, e.g. over flight timer, over load device, retiring cam for landing door locking actuation, car and counterweight safety gear, etc.

## Optional finishes

Motorised rise and fall shutters	Car rise and fall shutters	Emergency unlocking by means of a triangular key (standard for EN 81.3)	Additional shelves for the car. Car prearranged for multi-shelf set
			

Car lighting	Car heating system with thermostat	Intercom system for voice communication between floors	Power supply cabinet and machine room lighting
			

# Customization of the lift



## Special version, materials and colours

### Low headroom

Drive unit integrated in the headroom side wall.  
Headroom dimensions:  
with rise and fall shutters 1400 mm,  
hinged doors 1100 mm.  
Available only for 24-50 kg versions.



### Double decker

Double car to transport food, medicines, clean/dirty load, especially suitable for canteens, hospitals, restaurants, etc.  
Combined landing doors: rise and fall shutters to access the upper car, hinged door for the lower car.



## Standard colours and materials



Baked enamel  
pearl grey RAL 7038



Satin stainless steel  
AISI 304 grain 320

**Daldoss RAL colours range** *(Complete RAL colours range available on request, as optional)*



Greyish aluminium RAL 9007 baked enamel



Rust 56RO 3112 baked enamel

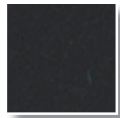

Intense black RAL 9005 baked enamel



Micaceous anthracite 5620 2503 baked enamel



Light ivory RAL 1015 baked enamel



Brilliant aluminium RAL 9006 baked enamel

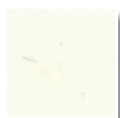

Cream white RAL 9001 baked enamel

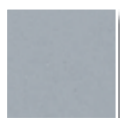

Window grey RAL 7040 baked enamel

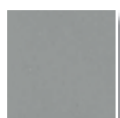

Stone grey RAL 7030 baked enamel



Pure white RAL 9010 baked enamel



Pearl white RAL 1013 baked enamel

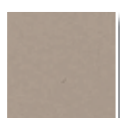

Beige RAL 1019 baked enamel

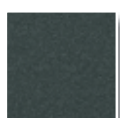

Anthracite grey RAL 7016 baked enamel





# Technical characteristics



## Always equipped with structure supported frame for indoor installations

**Microlift** is always equipped with structure supported frame, fully automatic operation and lift positions indicators on each floor. For the installation, only an opening through each floor is required. Installation times for 2 stops standard models can be only 8 hours, depending on model and site conditions.

Standard	
Drive unit	1-phase ore 3-phase electrical motor equipped with electromagnetic disk brake and reduction worm gear box. Standard speed 0.35 m/s (24-50-100 kg) - 0.17 m/s (200-300 kg).
Operation	Fully automatic.
Rated load	From 24 to 300 kg.
Stops	From 2 to 12 in standard configurations.
Travel	Up to 30 meters.
Car	Constructed in mild steel, finished in gray baked enamel RAL 7038 (standard), with Daldoss RAL colours range or in stainless steel AISI 304 (optional). All versions have the base and a removable shelf in stainless steel AISI 304 (only for 24-50-100 kg).
Entrances	Up to 3 entrances can be fitted on each floor, in line, opposite or adjacent.
Landing doors	Rise and fall shutters or single manual hinged door. Baked enamel RAL 7038 finish (standard), or with Daldoss RAL colours range finish or in stainless steel AISI 304 (optional). Fitted with mechanical safety lock with electrical striker.
Landing push button station	Call and dispatch push button at each floor, "lift arrival", "lift position" and "lift occupied" indicators. Audible lift arrival buzzer.

**Microlift** is available with a wide range of finishes and technical options, with guarantee of excellent performances in any kind of installations.

**Special lifts with customized dimensions available on request.**

Optional	
Drive unit	Speed 0.6 m/s (24-50-100 kg), 0.35 m/s (200-300 kg). VVF speed controller. Over flight timer. Timer to return lift to the main floor.
Car	Ceiling lighting fixture. Heating device and thermostat. Rise and fall car shutters in stainless steel AISI 304. Collapsible car gate for MDL models. Additional shelves, multi-shelf set. Over load device.
Landing doors	Fire rated EI 60 - EI 120 (only hinged doors). Rise and fall shutters with motorized opening.
Landing push button station	Key switch push button activation. Intercom. Waterproof station.
Various	Machine room door with baked enamel RAL 7038 finish (standard), with Daldoss RAL colours range or in stainless steel AISI 304 (optional). Fire rated EI 60 - EI 120 also available.

## Safety features

**Microlift** fully complies to the Machinery Directive 2006/42/EC and obtained the Type Examination Certificate released by the Italian Notified Body IMQ. Daldoss is able to supply various safety equipment to comply with different national and international standards and regulations.



## Microlift®

Technical data	
Drive system	Traction type.
Rated load	24-50-100-200-300 kg.
Car speed	0.35 m/s (24-50-100 kg). 0.17 m/s (200-300 kg).
Power supply	All principal forms, both 1 and 3 phase.
Motor power	From 0.33 kW to 1.1 kW according to model, speed and power supply.

### Operation

The microprocessor controlled operation guarantees optimum performances and extremely low noise production.

### Quality

Intelligent and modern management, maximum product standardization, highly automated production and the adoption of avant-garde technology enable Daldoss to guarantee constant compliance to the standards provided for by UNI EN ISO 9001:2008 Company Certification.

### Standard EN 81.3 (safety rules for the construction and installation of lifts and service lifts, models from 50 to 300 kg)

The standard is applied in all UE-CEE Countries and all **Microlift** installations inside UE will be supplied according to this standard. The lift will be integrated with further components in order to guarantee the safety requirements given by the standard, both for the use of the product and the maintenance operations made inside or outside the shaft.

# Technical characteristics



## Overall dimensions

(special dimensions available on request)

Table of dimensions										
Model	Rated load (kg)	Car (mm)			Shaft (mm)		Doors B position (mm)		Doors AC position (mm)	
		Width CW	Depth CD	High CH	Width SW	Depth SD	Width DW	High DH	Width DW	High DH
DD	24/50	320	510	800	540	745	ND	ND	320	800
DL	24/50	420	545	800	660	835	320	800	420	800
39/5	24/50	520	420	800	760	710	420	800	320	800
NR	24/50	520	520	800	760	810	420	800	420	800
41/5	24/50	520	520	1000	760	810	420	1000	420	1000
1/5	24/50	520	620	800	760	910	420	800	520	800
3/5	24/50	520	720	800	760	1010	420	800	620	800
4/5	24/50	520	720	1000	760	1010	420	1000	620	1000
42/5	24/50	620	420	800	860	710	520	800	320	800
5/5	24/50	620	520	800	860	810	520	800	420	800
MG	24/50	620	620	800	860	910	520	800	520	800
48/5	24/50	620	620	1000	860	910	520	1000	520	1000
7/5	24/50	620	720	800	860	1010	520	800	620	800
50/5	24/50	720	420	800	960	710	620	800	320	800
13/5	24/50	720	520	800	960	810	620	800	420	800
17/5	24/50	720	620	800	960	910	620	800	520	800
21/5	24/50	720	720	800	960	1010	620	800	620	800
22/5	24/50	720	720	1000	960	1010	620	1000	620	1000
29/5	24/50	820	620	800	1060	910	720	800	520	800
33/5	24/50	820	720	800	1060	1010	720	800	620	800
34/5	24/50	820	720	1000	1060	1010	720	1000	620	1000
MGS	100	620	620	800	860	910	520	800	520	800
11/10	100	620	820	800	860	1110	520	800	720	800
54/10	100	720	720	800	960	1010	620	800	620	800
MGT	100	720	720	1000	960	1010	620	1000	620	1000
23/10	100	720	820	800	960	1110	620	800	720	800
24/10	100	720	820	1000	960	1110	620	1000	720	1000
37/10	100	820	820	800	1060	1110	720	800	720	800
38/10	100	820	820	1000	1060	1110	720	1000	720	1000
MDL1	100	820	820	1200	1060	1110	720	1200	720	1200
62/20	200	830	730	1200	1070	1060	720	1200	620	1200
MDL2	200	1000	1000	1200	1240	1330	900	1200	900	1200
MDL3	300	1000	1000	1200	1240	1330	900	1200	900	1200

Some of the above dimensions can be varied to suit your individual requirements by modification of stock models or by special manufacture. Please, contact our Commercial department for details.

## 24-50-100 Kg

Min. S= \* (without safety gear)  
 Min. S=600 (with safety gear)

\* =130+CH/2 (bi-parting door)  
 \* =400 (hinged door)

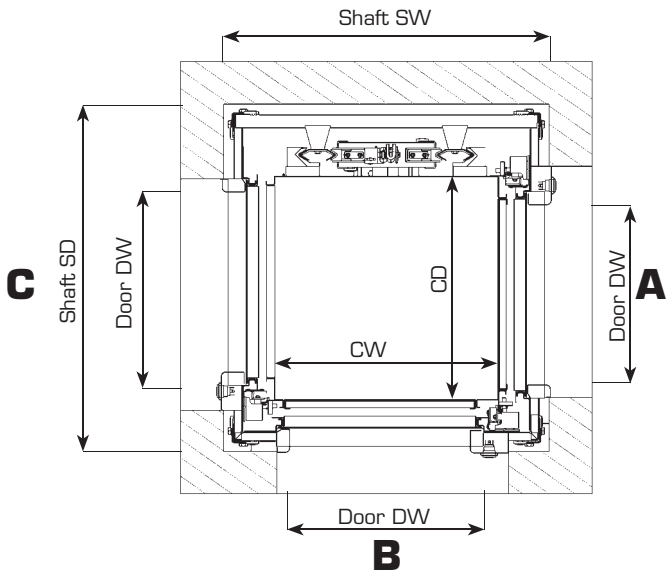
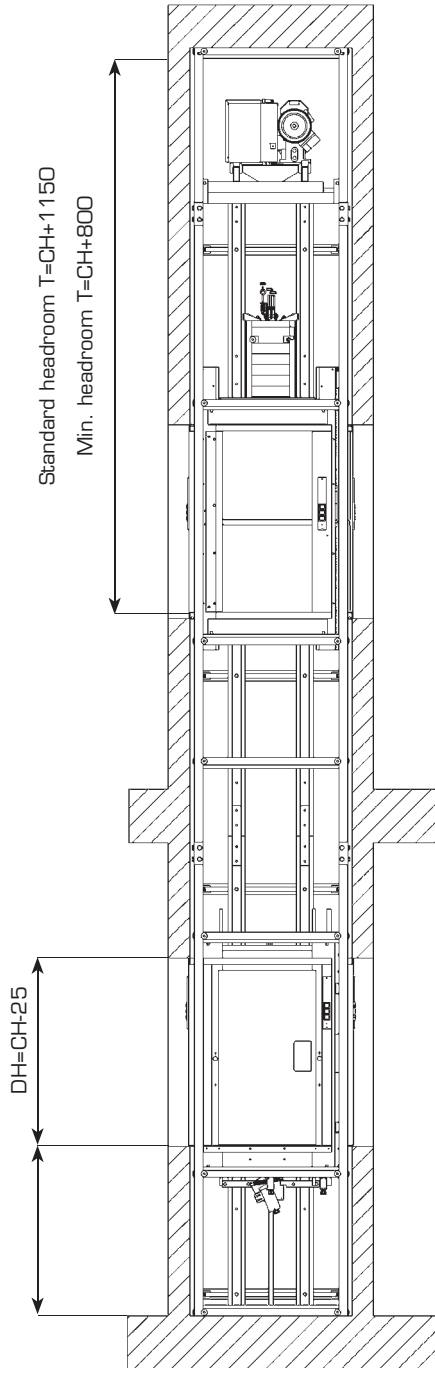

## 200-300 Kg

For different dimensions check feasibility

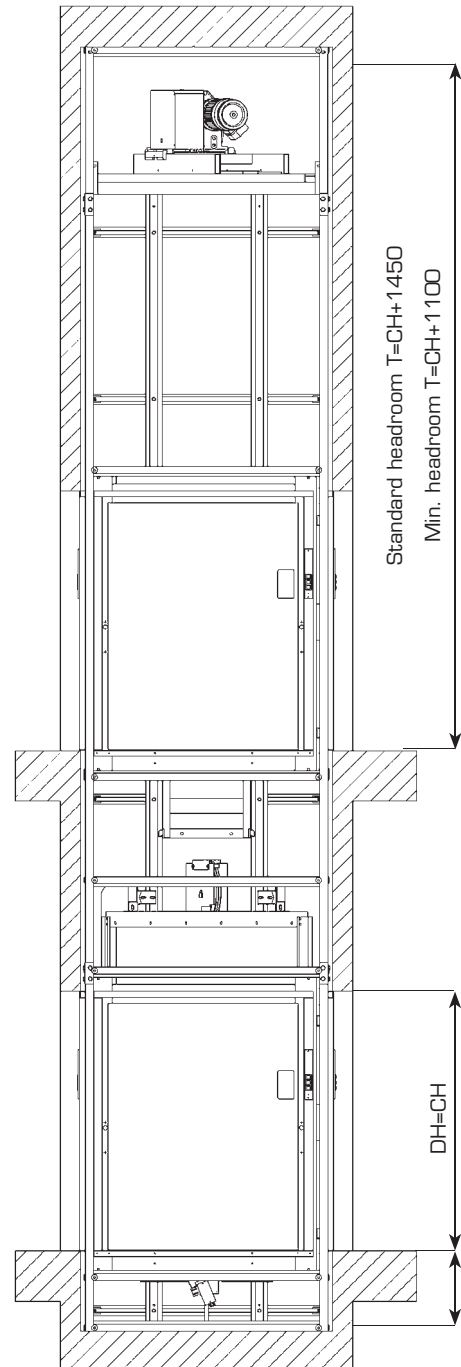

Min. S=400 (without safety gear)  
 Min. S=600 (with safety gear)

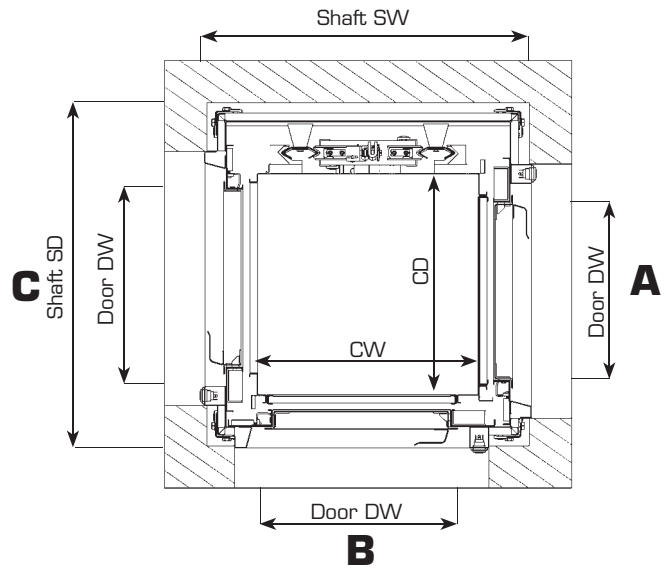



*Installation in a wine shop (Italy),  
model 50 kg, with satin stainless steel AISI 304 car  
and shaft cladding.*

*Installation in a printing house (UK),  
model 50 kg, standard finishes and wall cladding.  
Thanks to the structure supported frame **Microlift**  
can be installed also without a shaft.*



*Installation at Schipol airport (The Netherlands).  
Model 100 kg.*

# The other Daldoss products



## A complete range of lifts for the vertical transport of goods and people

Daldoss can solve any problem in the vertical transport, thanks to its wide range of products, which are able to give the right solution both in residential and commercial applications.

Daldoss now operates worldwide thanks to its distributors and partners, which guarantee an excellent after sale and maintenance service

with the highest quality levels. In addition to our employees, Daldoss makes use of many high level technical collaborations both with experts from research institutes and universities.

Since the Company was launched, more than 150,000 units have been built and sold around the world.

### **Microfreight® Classic- Microfreight® Plus**

A complete range of freight lifts, for the transport of goods only or goods with an attendant. Rated load from 500 to 1500 kg (1400 kg for Microfreight Plus model). It requires only a reduced pit or a small ramp. Always with structure supported frame, can be installed virtually anywhere. The ideal solution for warehouses, industries, supermarkets and other retail activities.



### **Level® - Level® Map- Level® Plus**

A complete range of platform lifts with capacity of 250, 300 and 500 kg. Available also with automatic control both in the car and at floors. Available with 100 mm pit, 2500 mm headroom and with optional structure supported frame both for indoor or outdoor applications.

The ideal solution for one family houses and residences, especially in presence of elderly and persons with impaired mobility.



### **Easylife®**

The compact hydraulic passenger lift mainly for residential buildings with capacity ranging from 180 kg to 550 kg and speed up to 0.5 m/sec. Available also with 200 mm pit, 2600 mm headroom and with structure supported frame both for internal and external applications. Lift can be equipped with automatic or semiautomatic doors, an ideal solution for existing buildings.

The lift for the impossible spaces.







## Guarantee



## Spare parts and maintenance

Daldoss and its partners can provide a maintenance service covering the whole operational life of each lift.

One of the principal objective of a customer focused company is the establishing of a lasting business relationships with its Customers, based on mutual trust and satisfaction. For this reason, Daldoss can

provide the original spare parts for all **Microlift** models. Moreover, all the **Microlift** lifts are supplied with 12 or 24 months guarantee valid from the date of the handover of the installation.

# Microlift®

## THE SERVICE LIFT



It is a product of the Cargo Division designed to move small goods between floors. **Microlift** is the world largest selling range of electronic service lift. You can find it



everywhere, thanks to its flexibility it can be adapted to any needs and type of installation.



The **Microlift** range is composed by more than 30 models available with different rated load starting from 24 to 300 kg.

All models are traction type, with drive unit and controller enclosed in the headroom.

**Microlift** is the ideal solution for private, industrial and commercial applications.

*Cargo Division*





**DALDOSS**  
PASSENGER & GOODS LIFTS

***Daldoss Elevation Spa***

Località Cirè 38057 Pergine Valsugana (Tn) - Italy

T. (0039) 0461 51 86 11

F. (0039) 0461 51 86 54

[www.daldoss.com](http://www.daldoss.com)